

DRAWING NAME	DESCRIPTION	DRAWING NAME	DESCRIPTION
DISP-200-PL.DWG	1-2HP disposer plan view	RSS-EL.DWG	Remote start/stop switch front view
CA12-200-PL.DWG	1-2HP disposer/12" cone package plan view	MSS-EL.DWG	Manual start/stop disposer control front view
CA15-200-PL.DWG	1-2HP disposer/15" cone package plan view	MSSLD-EL.DWG	Manual start/stop disposer control w/ line disconnect front view
CA18-200-PL.DWG	1-2HP disposer/18" cone package plan view	MRSS-EL.DWG	Manual reverse start/stop disposer control front view
DISP-PL.DWG	Typical disposer plan view	MRSSLD-PL.DWG	Manual reverse start/stop disposer control w/ line disconnect plan view
CA12-PL.DWG	12" disposer/cone package plan view	ARSS-PL.DWG	Automatic reverse start/stop control panel plan view
CA15-PL.DWG	15" disposer/cone package plan view	ARSSL-PL.DWG	Automatic reverse start/stop control panel w/ line disconnect plan view
CA18-PL.DWG	18" disposer/cone package plan view	ARSS2-PL.DWG	Automatic reverse start/stop control panel plan view
DISP-200-EL.DWG	1-2HP disposer front view	MRSSLD-EL.DWG	Manual reverse start/stop disposer control w/ line disconnect front view
CA12-200-EL.DWG	1-2HP disposer/12" cone package front view	ARSS-EL.DWG	Automatic reverse start/stop control panel front view
CA15-200-EL.DWG	1-2HP disposer/15" cone package front view	ARSSL-EL.DWG	Automatic reverse start/stop control panel w/ line disconnect front view
CA18-200-EL.DWG	1-2HP disposer/18" cone package front view	ARSS2-EL.DWG	Automatic reverse start/stop control panel front view
DISP-EL.DWG	Typical disposer front view	OFC 200-PL.DWG	WX disposer with offset chute and 18" cone plan view
CA12-EL.DWG	12" disposer/cone package front view	OFC-PL.DWG	Disposer with offset chute and 18" cone plan view
CA15-EL.DWG	15" disposer/cone package front view	OFC 200-EL.DWG	WX disposer with offset chute and 18" cone front view
CA18-EL.DWG	18" disposer/cone package front view	OFC-EL.DWG	Disposer with offset chute and 18" cone front view
SA-200-PL.DWG	1-2HP 6 1/2" sink assembly disposer plan view	PRINS-EL.DWG	Pre-rinse front view
SA-200-EL.DWG	1-2HP 6 1/2" sink assembly disposer front view	PRINS-PL.DWG	Pre-rinse plan view
SA-PL.DWG	6 1/2" sink assembly disposer plan view	SOLE-PL.DWG	Solenoid plan view
SA-EL.DWG	6 1/2" sink assembly disposer front view	SOLE-REL.DWG	Solenoid right side elevation
RSS-PL.DWG	Remote start/stop switch plan view	12CC-PL.DWG	12" cone bowl cover plan view
MSS-PL.DWG	Manual start/stop disposer control plan view	15CC-PL.DWG	15" cone bowl cover plan view
MSSLD-PL.DWG	Manual start/stop disposer control w/ line disconnect plan view	18CC-PL.DWG	18" cone bowl cover plan view
MRSS-PL.DWG	Manual reverse start/stop disposer control plan view		

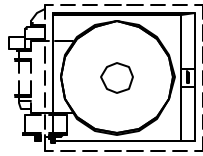

S914-PL.DWG

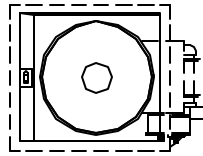

S914-LEFTHAND-PL.DWG

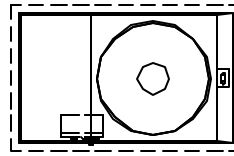

P914-PL.DWG

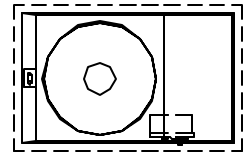

P914-LEFTHAND-PL.DWG

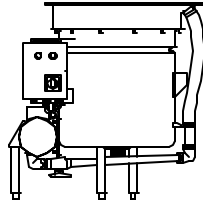

S914-EL.DWG

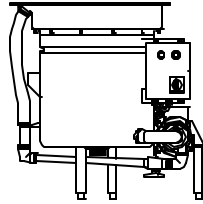

S914-LEFTHAND-EL.DWG

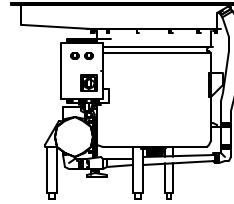

P914-EL.DWG

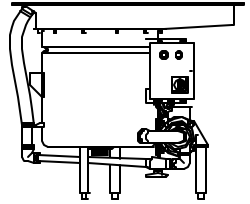

P914-LEFTHAND-EL.DWG

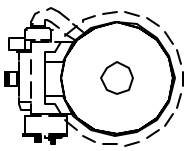

S419-PL.DWG

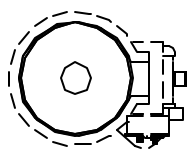

S419-LEFTHAND-PL.DWG

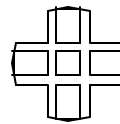

RACKGUIDE.DWG

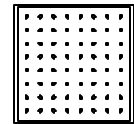

20-RACK.DWG

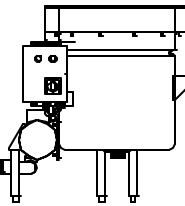

S419-EL.DWG

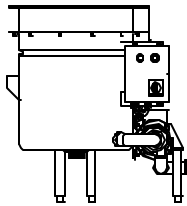

S419-LEFTHAND-EL.DWG

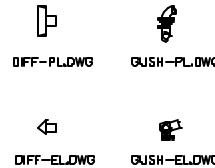

DIFF-PL.DWG

GUSH-PL.DWG

DIFF-EL.DWG

GUSH-EL.DWG



SAL.DWG

SAL.DWG

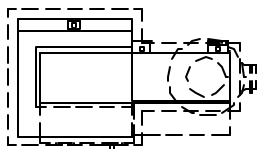

SM-PL.DWG

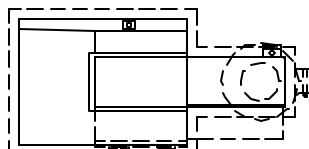

PSM-PL.DWG

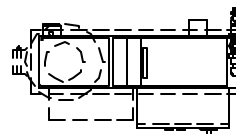

TVL-PL.DWG

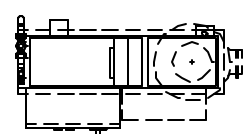

TVR-PL.DWG

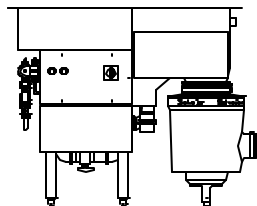

SM-EL.DWG

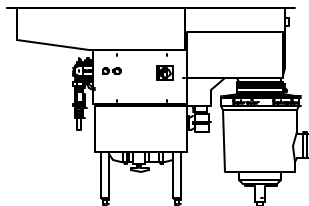

PSM-EL.DWG

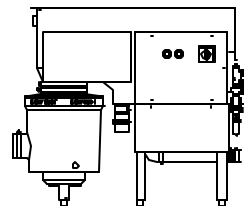

TVL-EL.DWG

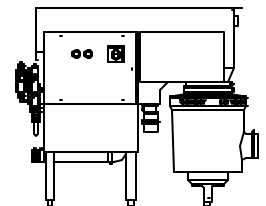

TVR-EL.DWG

DRAWING NAME	DESCRIPTION	DRAWING NAME	DESCRIPTION	DRAWING NAME	DESCRIPTION
S914-PL.DWG	S914 collector plan view	S419-LEFTHAND-PL.DWG	S419 LH collector plan view	SAL.DWG	Simulated operator
S914-LEFTHAND-PL.DWG	S914 LH collector plan view	S419-EL.DWG	S419 collector front view	SM-PL.DWG	Scrapmaster plan view
P914-PL.DWG	P914 collector plan view	S419-LEFTHAND-EL.DWG	S419 LH collector front view	PSM-PL.DWG	Pot/Pan Scrapmaster plan view
P914-LEFTHAND-PL.DWG	P914 LH collector plan view	RACKGUIDE.DWG	Rack guide plan view	TVL-PL.DWG	Troughveyor left hand plan view
S914-EL.DWG	S914 collector front view	20-RACK.DWG	Dish rack plan view	TVR-PL.DWG	Troughveyor right hand plan view
S914-LEFTHAND-EL.DWG	S914 LH collector front view	DIFF-PL.DWG	Diffuser plan view	SM-EL.DWG	Scrapmaster front view
P914-EL.DWG	P914 collector front view	DIFF-EL.DWG	Diffuser front view	PSM-EL.DWG	Pot/Pan Scrapmaster front view
P914-LEFTHAND-EL.DWG	P914 LH collector front view	GUSH-PL.DWG	Gusher head plan view	TVL-EL.DWG	Troughveyor left hand front view
S419-PL.DWG	S419 collector plan view	GUSH-EL.DWG	Gusher head front view	TVR-EL.DWG	Troughveyor right hand front view

DISP-3D.DWG

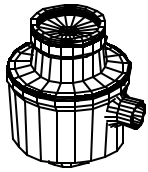

DISPSA-200-3D.DWG

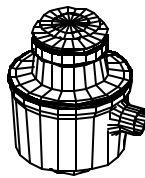

CA12-20D-3D.DWG

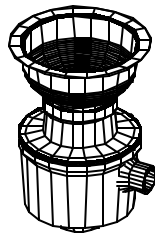

CA15-20D-3D.DWG

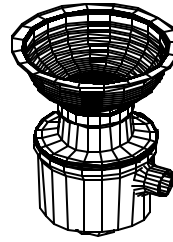

CA18-20D-3D.DWG

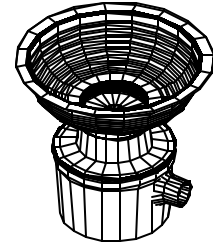

DISPSA-3D.DWG

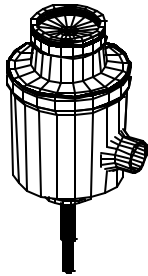

DISP-3D.DWG

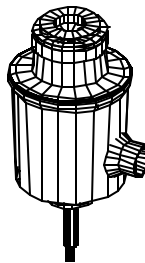

CA12-3D.DWG

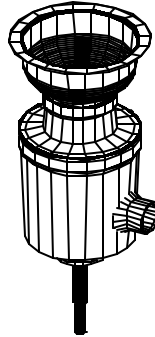

CA15-3D.DWG

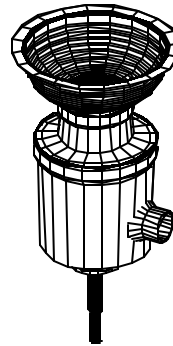

CA18-3D.DWG

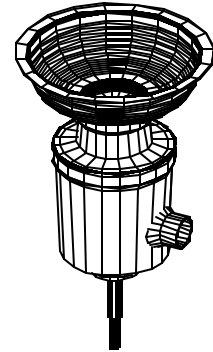

OFC-200-3D

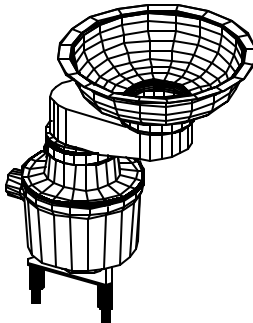

DISP-OFC-3D.DWG

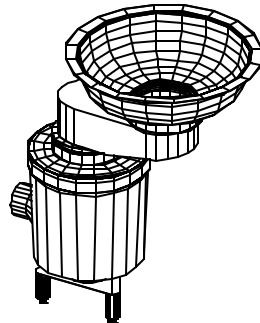

DISPS-3D.DWG

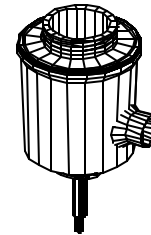

RSS-3D.DWG



MSS-3D.DWG



MSSLD-3D.DWG

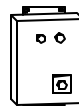

MRSS-3D.DWG

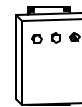

MRSSLD-3D.DWG

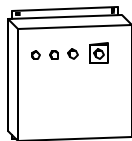

ARSS2-3D.DWG

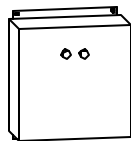

ARSS-3D.DWG

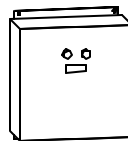

ARSSLD-3D.DWG

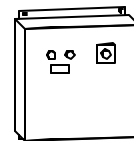

DRAWING NAME	DESCRIPTION	DRAWING NAME	DESCRIPTION
DISP-200-3D.DWG	1-2HP disposer	DISP-OFC-3D	Standard disposer with offset chute
DISPSA-200-3D.DWG	1-2HP disposer/sink adaptor	DISPS-3D.DWG	Standard disposer with short top housing
CA12-200-3D.DWG	1-2HP disposer/12" cone package	RSS-3D.DWG	Remote start/stop switch
CA15-200-3D.DWG	1-2HP disposer/15" cone package	MSS-3D.DWG	Manual start/stop disposer control
CA18-200-3D.DWG	1-2HP disposer/18" cone package	MSSLD-3D.DWG	Manual start/stop disposer control w/ line disconnect
DISP-3D.DWG	Standard disposer	MRSS-3D.DWG	Manual reverse start/stop disposer control
DISPSA-3D.DWG	Disposer with 6 1/2" sink assembly	MRSSLD-3D.DWG	Manual reverse start/stop disposer control w/ line disconnect
CA12-3D.DWG	12" disposer/cone package	ARSS2-3D.DWG	Automatic reverse start/stop control panel
CA15-3D.DWG	15" disposer/cone package	ARSS-3D.DWG	Automatic reverse start/stop control panel
CA18-3D.DWG	18" disposer/cone package	ARSSLD-3D.DWG	Automatic reverse start/stop control panel w/ line disconnect
OFC-200-3D	1-2HP disposer with offset chute	OFC-3D.DWG	Disposer with offset chute

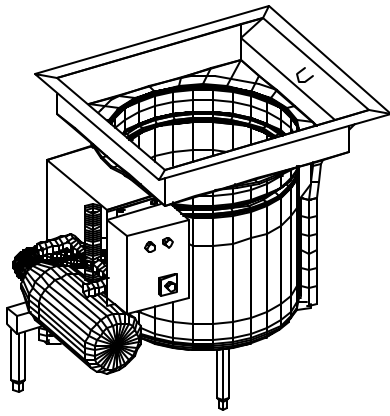

S914-3D.DWG

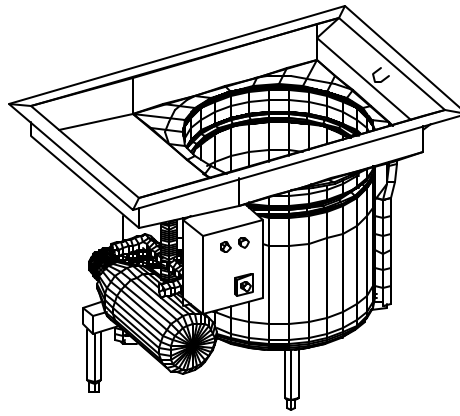

P914-3D.DWG

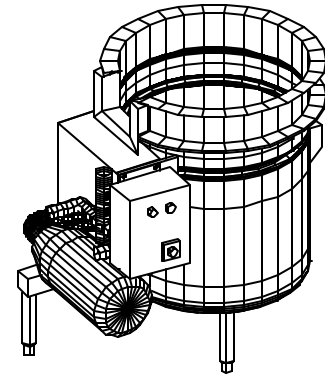

S419-3D.DWG

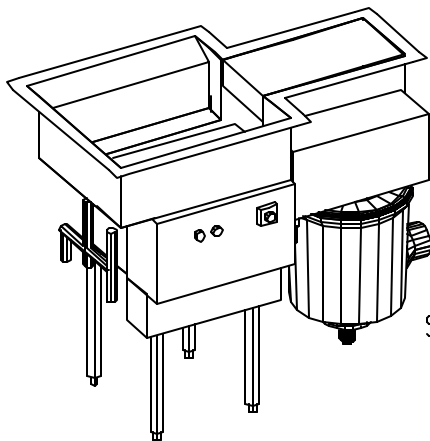

SM-3D.DWG

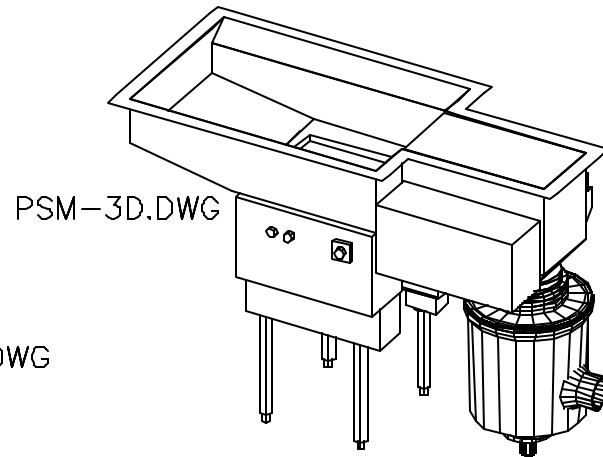

PSM-3D.DWG

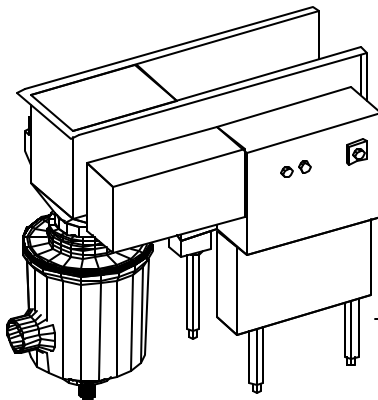

TVL-3D.DWG

TVR-3D.DWG

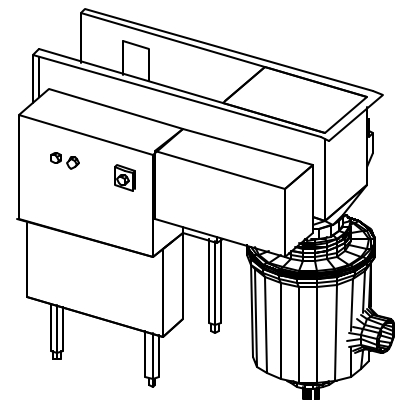

DRAWING NAME	DESCRIPTION
S914-3D.DWG	S914 collector
P914-3D.DWG	P914 collector
S419-3D.DWG	S419 collector
SM-3D.DWG	Scrapmaster
PSM-3D.DWG	Pot/Pan Scrapmaster
TVL-3D.DWG	Troughveyor left hand
TVR-3D.DWG	Troughveyor right hand